

Analog Devices Welcomes Hittite Microwave Corporation

NO CONTENT ON THE ATTACHED DOCUMENT HAS CHANGED



THIS PAGE INTENTIONALLY LEFT BLANK



Typical Applications

The HMC-C046 is ideal for:

- Point-to-Point Radios
- Point-to-Multi-Point Radios & VSAT
- Test Equipment & Sensors
- Military End-Use

Functional Diagram

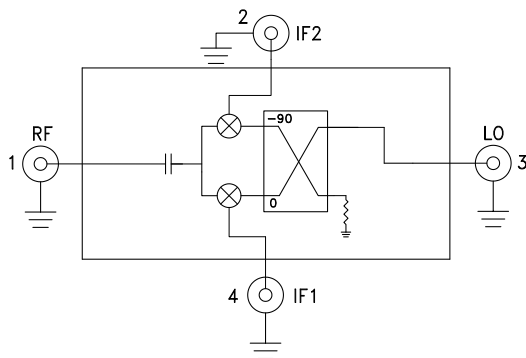

Features

- Wide IF Bandwidth: DC - 4.5 GHz
- Image Rejection: 24 dB
- LO to RF Isolation: 42 dB
- High Input IP3: 22.5 dBm
- Hermetically Sealed Module
- Field Replaceable SMA Connectors
- 55 to +85 °C Operating Temperature

General Description

The HMC-C046 is a passive I/Q MMIC mixer housed in a miniature hermetic module which can be used as either an Image Reject Mixer (IRM) or a Single Sideband Upconverter. The module utilizes two standard Hittite double balanced mixer cells and a 90 degree hybrid fabricated on a GaAs MESFET process. A low frequency quadrature hybrid was used to produce a 100 MHz Upper Side Band (USB) IF output. This MMIC based module is a more reliable and consistent alternative to hybrid style I/Q Mixers and Single Sideband Converter assemblies. The module features removable SMA connectors which can be detached to allow direct connection of the I/O pins to a microstrip or coplanar circuit.

Electrical Specifications, $T_A = +25^\circ \text{C}$, $IF = 100 \text{ MHz}$, $LO = +17 \text{ dBm}^*$

Parameter	Min.	Typ.	Max.	Units
Frequency Range, RF/LO	20 - 31			GHz
Frequency Range, IF	DC - 4.5			GHz
Conversion Loss (As IRM)		10	15	dB
Image Rejection	17	24		dB
1 dB Compression (Input)		17		dBm
LO to RF Isolation	29	42		dB
LO to IF Isolation	15	30		dB
IP3 (Input)		22.5		dBm
Amplitude Balance		0.3		dB
Phase Balance		4		Deg

* Unless otherwise noted, all measurements performed as downconverter.



Data taken As IRM With External IF 90° Hybrid
Conversion Gain vs. Temperature

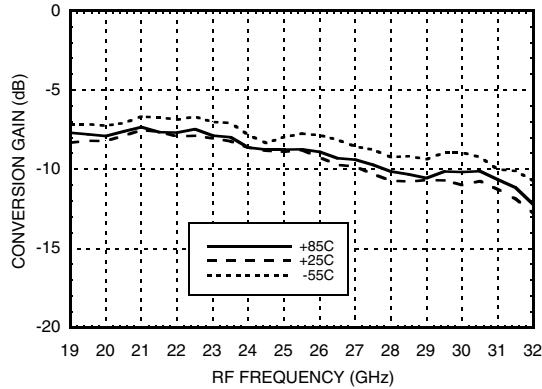
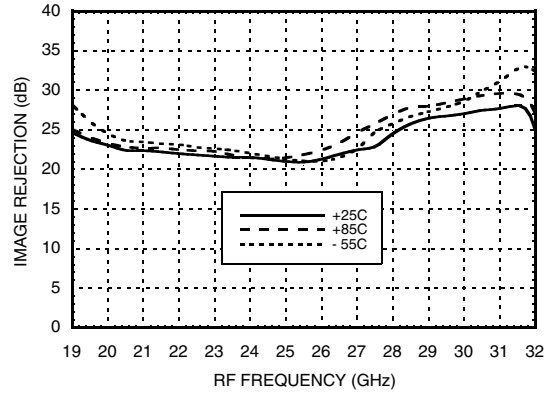
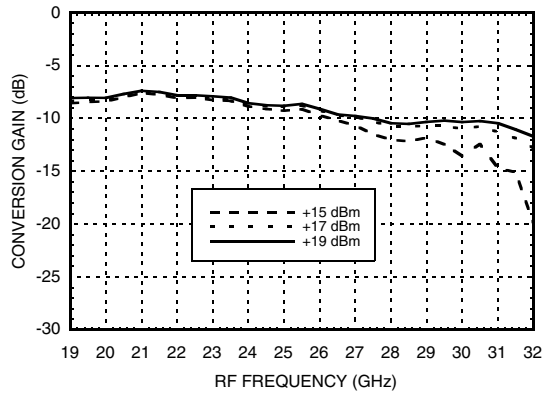

Image Rejection vs. Temperature



Conversion Gain vs. LO Drive



Return Loss

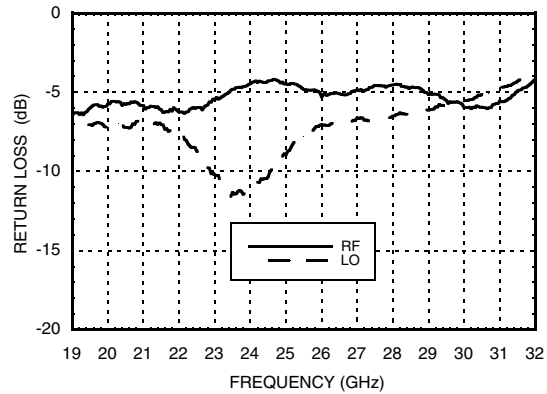

Input P1dB vs. Temperature

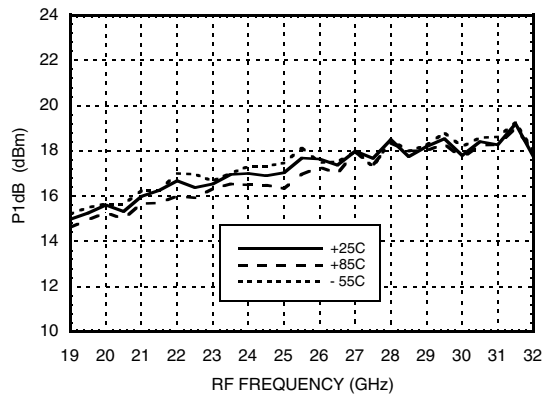

Input IP3 vs. LO Drive

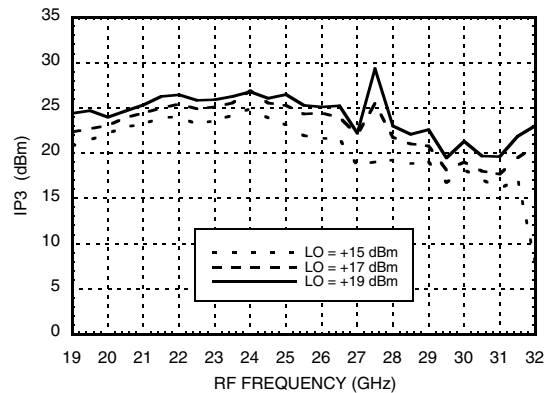



IF1 & IF2 Port Characteristics

Isolation, LO=+10dBm

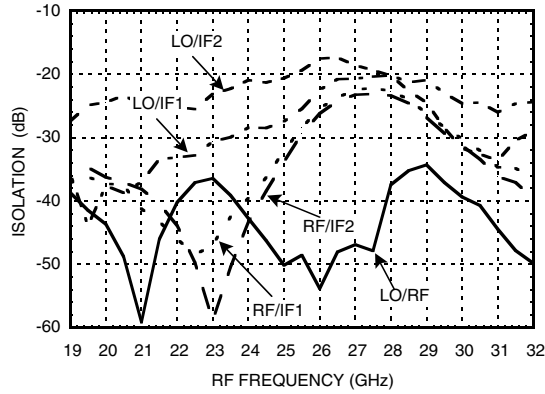

IF Bandwidth*

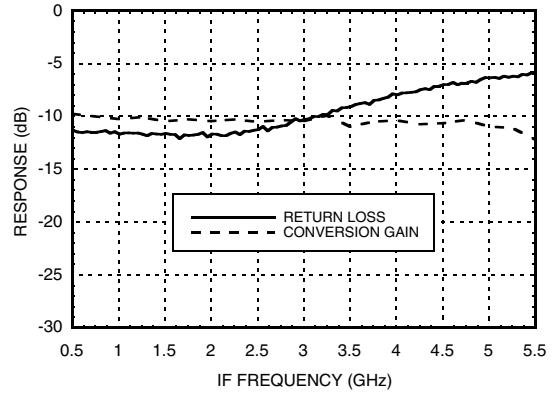

Amplitude Balance vs. LO Drive

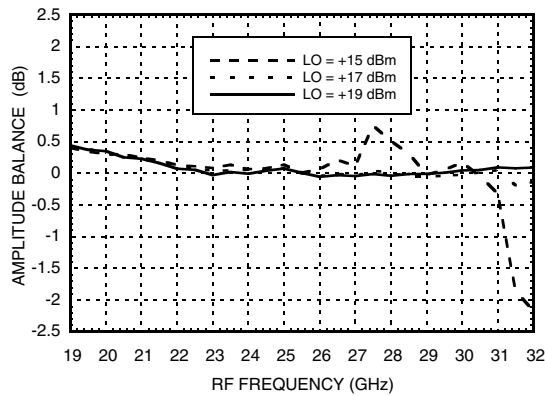

Phase Balance vs. LO Drive

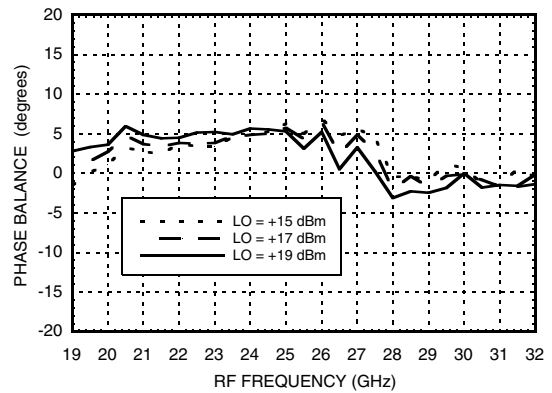

Upconverter Performance Conversion Gain vs. LO Drive

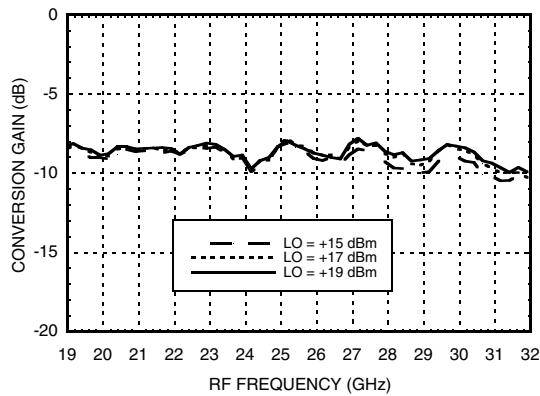

Upconverter Performance Sideband Rejection vs. LO Drive

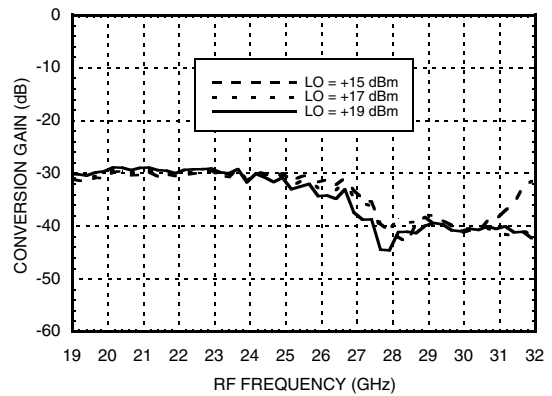

* Conversion gain data taken with external IF 90° hybrid

**Absolute Maximum Ratings**

RF / IF Input	13 dBm
LO Drive	27 dBm
Storage Temperature	-65 to +150 °C
Operating Temperature	-55 to +85 °C

MxN Spurious Outputs

mRF	nLO				
	0	1	2	3	4
0	xx	-13	27	xx	xx
1	18	0	35	52	xx
2	76	74	87	74	82
3	xx	83	87	77	87
4	xx	xx	82	87	87

RF = 24.5 GHz @ -10 dBm
LO = 24.4 GHz @ +17 dBm
Data taken without IF 90° hybrid
All values in dBc with reference to output power at IF= 100 MHz



**ELECTROSTATIC SENSITIVE DEVICE
OBSERVE HANDLING PRECAUTIONS**

Outline Drawing

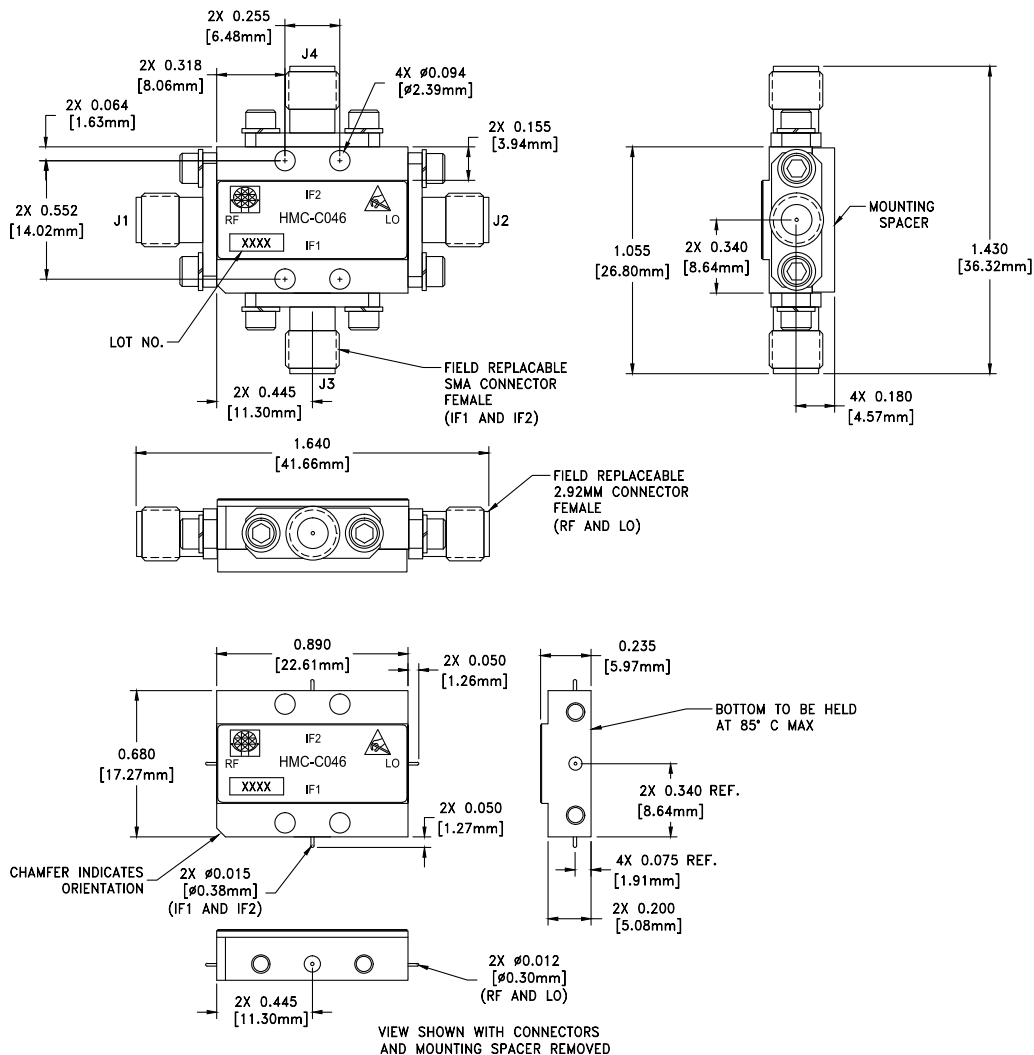

Package Information

Package Type	C-4B
Package Weight [1]	20 gms (Typ.)
Spacer Weight	2.6 gms (Typ.)

[1] Package weight includes the connectors

[2] ± 1 gms Tolerance

NOTES:

- 1.0 PACKAGE, LEADS, COVER MATERIAL: KOVAR™
- 2.0 FINISH: GOLD PLATE OVER NICKEL PLATE
- 3.0 MOUNTING SPACER: NICKEL PLATED ALUMINUM.
- 4.0 ALL DIMENSIONS ARE IN INCHES [MILLIMETERS].
- 5.0 TOLERANCES:
 - 5.1 .XX = ± 0.02
 - 5.2 .XXX = ± 0.10
- 6.0 FIELD REPLACEABLE SMA CONNECTORS. TENSOLITE 5602-5CCSF OR EQUIVALENT.
- 7.0 TO MOUNT MODULE TO SYSTEM PLATFORM REPLACE 0-80 HARDWARE WITH DESIRED MOUNTING SCREWS.

Pin Descriptions

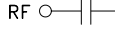
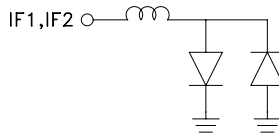
Pin Number	Function	Description	Interface Schematic
1	RF	This pin is AC coupled and matched to 50 Ohms.	
2	IF2	This pin is DC coupled. For applications not requiring operation to DC, this port should be DC blocked externally using a series capacitor whose value has been chosen to pass the necessary IF frequency range. For operation to DC, this pin must not source/sink more than 3mA of current or part non-function and possible part failure will result.	
4	IF1		
3	LO	This pin is DC coupled and matched to 50 Ohms.	